

Longpass Filter

Schneider-Kreuznach magnetron sputtered industrial longpass filters impress with steep slopes and high transmission at stable cut-on wavelengths. The very flat surface makes them ideal for high end machine vision systems in factory automation. All longpass filters come with superior antireflection coating. Schneider-Kreuznach longpass filters are RoHS conform. Custom sizes are available on request.



Key Features

- Ave. Transmittance 95 %
- Steep Slopes
- Wavelength Tolerance +/- 1 %
- Ultra Low Reflection
- Deep Blocking / High OD

Applications

- Metrology
- 3D Measurement
- Food & Beverage Inspection
- Automotive
- Security / Surveillance

General technical specifications

according to ISO 10110

Parallelism	1'
Surface	19-30mm: 5/2x0,10 C2 x 0,10 L3x0,008 31-50mm: 5/2x0,16 C1 x 0,16 L3x0,008 51-64mm: 5/3x0,16 C3 x 0,16 L3x0,008
Wavefront distortion	19 – 30 mm:13/1 (0.2) 31 – 50 mm:13/1 (0.25) 51 – 64 mm:13/1 (0.35)
Thickness	2.0 +/- 0.08 mm
Climate Testing	
Slow temperature cycling	DIN ISO 9022-2-14-03 -1
Damp heat, cyclic	DIN ISO 9022-2-16-01-1
Chemical resistant	DIN ISO 9011-4-04-05
Adhesive strength	DIN ISO 9211-4-02-03

Longpass Filter LP 400 HT

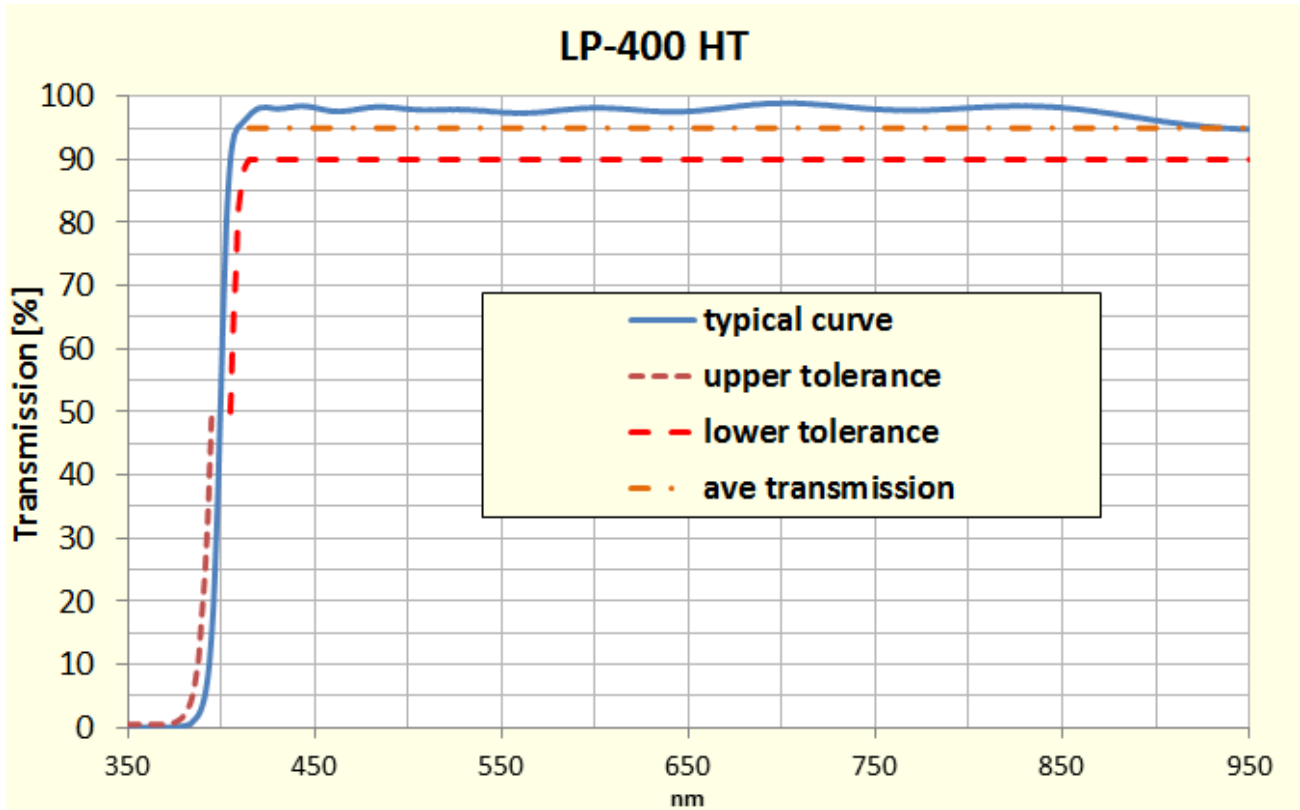

Technical specifications

according to ISO 10110

Angle of incident	0° +/-8°
Cut-on wavelength	400 +/- 5 nm
Transmittance	415 - 950 nm: T _{ave} > 95%, T _{abs} > 90%
Blocking	UV - 370 nm: T _{abs} < 0.5%
AR coating	MCXL

unmounted	filter glass	ID	mounted	filter	ID
19 mm	IFG LP 400 HT 19,0 2-0001	1087206	CMT	IF LP 400 HT CMT	
27 mm	IFG LP 400 HT 27,0 2-0001	1087207	SH 25.5	IF LP 400 HT SH 25.5	1088527
34 mm	IFG LP 400 HT 34,0 2-0001	1087208	SH 27.0	IF LP 400 HT SH 27.0	1088474
43 mm	IFG LP 400 HT 43,0 2-0001	1087209	SN1 30.5	IF LP 400 HT SN1 30.5	
55 mm	IFG LP 400 HT 55,0 2-0001	1087210	SH 35.5	IF LP 400 HT SH 35.5	1091099
64 mm	IFG LP 400 HT 64,0 2-0001	1087211	SH 37.0	IF LP 400 HT SH 37.0	
			SH 39.0	IF LP 400 HT SH 39.0	
			SH 40.5	IF LP 400 HT SH 40.5	
			SH 43.0	IF LP 400 HT SH 43.0	
			SH 46.0	IF LP 400 HT SH 46.0	
			SH 49.0	IF LP 400 HT SH 49.0	
			SH 52.0	IF LP 400 HT SH 52.0	
			SH 55.0	IF LP 400 HT SH 55.0	
			SH 58.0	IF LP 400 HT SH 58.0	
			SH 62.0	IF LP 400 HT SH 62.0	
			SH 67.0	IF LP 400 HT SH 67.0	1088475

Longpass Filter LP 430 HT

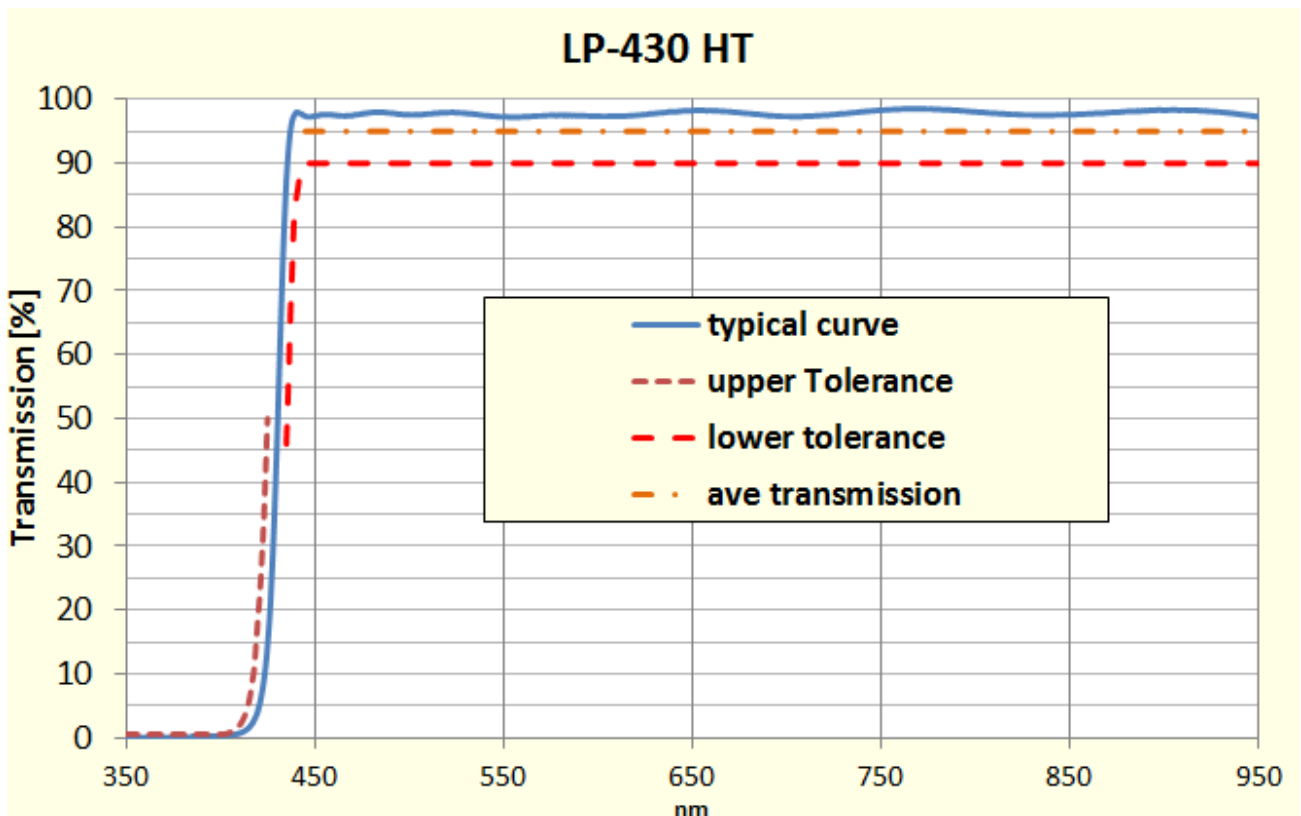

Technical specifications

according to ISO 10110

Angle of incident	0° +/- 8°
Cut-on wavelength	430 +/- 5 nm
Transmittance	445 - 950 nm: T _{ave} > 95%, T _{abs} > 90%
Blocking	UV - 400 nm: T _{abs} < 0.5%
AR coating	MCXL

unmounted	filter glass	ID	mounted	filter	ID
19 mm	IFG LP 430 HT 19,0 2-0001	1082487	CMT	IF LP 430 HT CMT	1091644
27 mm	IFG LP 430 HT 27,0 2-0001	1082488	SH 25.5	IF LP 430 HT SH 25.5	1085698
34 mm	IFG LP 430 HT 34,0 2-0001	1082489	SH 27.0	IF LP 430 HT SH 27.0	
43 mm	IFG LP 430 HT 43,0 2-0001	1082490	SN1 30.5	IF LP 430 HT SN1 30.5	
55 mm	IFG LP 430 HT 55,0 2-0001	1082491	SH 35.5	IF LP 430 HT SH 35.5	1091104
64 mm	IFG LP 430 HT 64,0 2-0001	1082492	SH 37.0	IF LP 430 HT SH 37.0	
			SH 39.0	IF LP 430 HT SH 39.0	
			SH 40.5	IF LP 430 HT SH 40.5	1087681
			SH 43.0	IF LP 430 HT SH 43.0	
			SH 46.0	IF LP 430 HT SH 46.0	
			SH 49.0	IF LP 430 HT SH 49.0	
			SH 52.0	IF LP 430 HT SH 52.0	
			SH 55.0	IF LP 430 HT SH 55.0	1085666
			SH 58.0	IF LP 430 HT SH 58.0	
			SH 62.0	IF LP 430 HT SH 62.0	
			SH 67.0	IF LP 430 HT SH 67.0	

Longpass Filter LP 460 HT

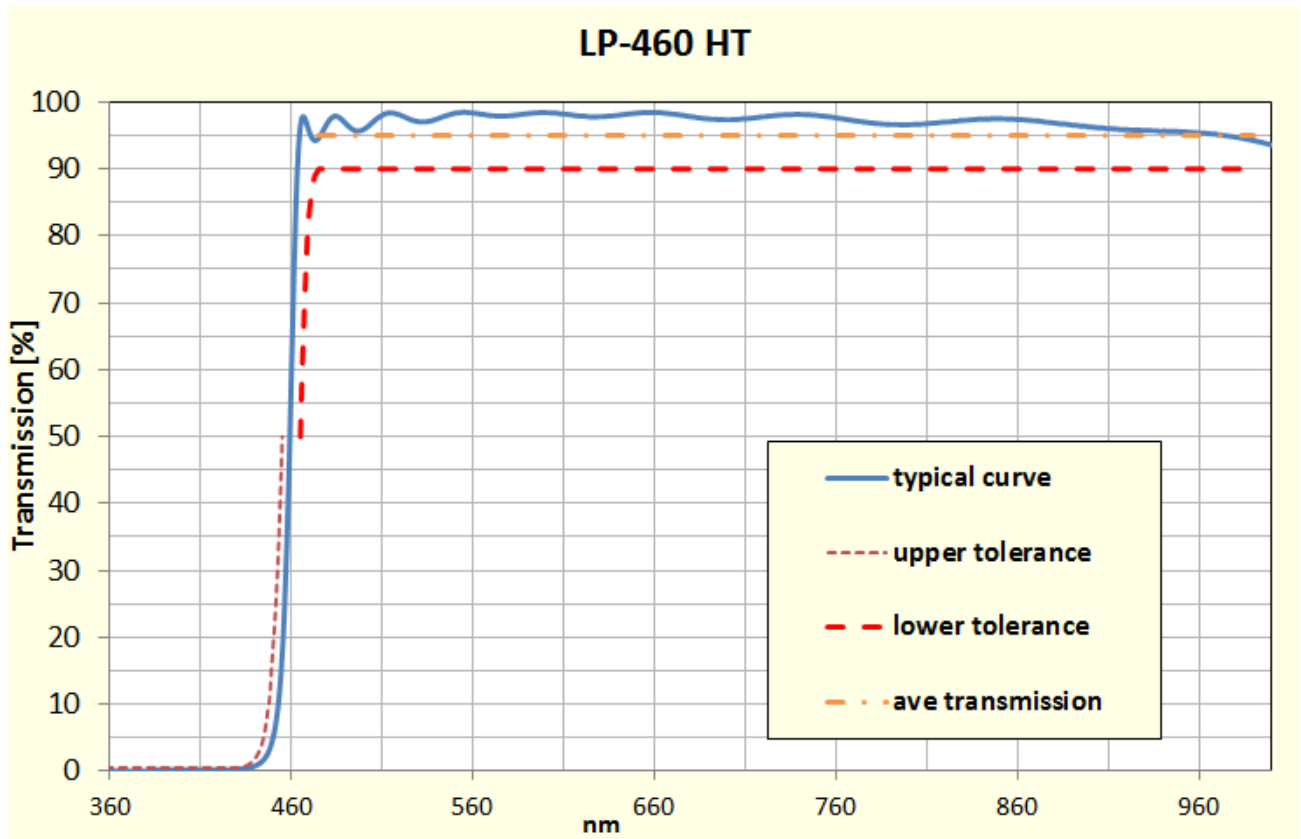

Technical specifications

according to ISO 10110

Angle of incident	0° +/- 8°
Cut-on wavelength	460 +/- 5 nm
Transmittance	475 – 980 nm: T _{ave} > 95%, T _{abs} > 90%
Blocking	UV – 430 nm: T _{abs} < 0.5%
AR coating	MCXL

unmounted	filter glass	ID	mounted	filter	ID
19 mm	IFG LP 460 HT 19,0 2-0001	1082499	CMT	IF LP 460 HT CMT	
27 mm	IFG LP 460 HT 27,0 2-0001	1082500	SH 25.5	IF LP 460 HT SH 25.5	
34 mm	IFG LP 460 HT 34,0 2-0001	1082501	SH 27.0	IF LP 460 HT SH 27.0	
43 mm	IFG LP 460 HT 43,0 2-0001	1082502	SN1 30.5	IF LP 460 HT SN1 30.5	
55 mm	IFG LP 460 HT 55,0 2-0001	1082503	SH 35.5	IF LP 460 HT SH 35.5	
64 mm	IFG LP 460 HT 64,0 2-0001	1082504	SH 37.0	IF LP 460 HT SH 37.0	
			SH 39.0	IF LP 460 HT SH 39.0	
			SH 40.5	IF LP 460 HT SH 40.5	
			SH 43.0	IF LP 460 HT SH 43.0	
			SH 46.0	IF LP 460 HT SH 46.0	
			SH 49.0	IF LP 460 HT SH 49.0	
			SH 52.0	IF LP 460 HT SH 52.0	
			SH 55.0	IF LP 460 HT SH 55.0	
			SH 58.0	IF LP 460 HT SH 58.0	
			SH 62.0	IF LP 460 HT SH 62.0	
			SH 67.0	IF LP 460 HT SH 67.0	

Longpass Filter LP 495 HT

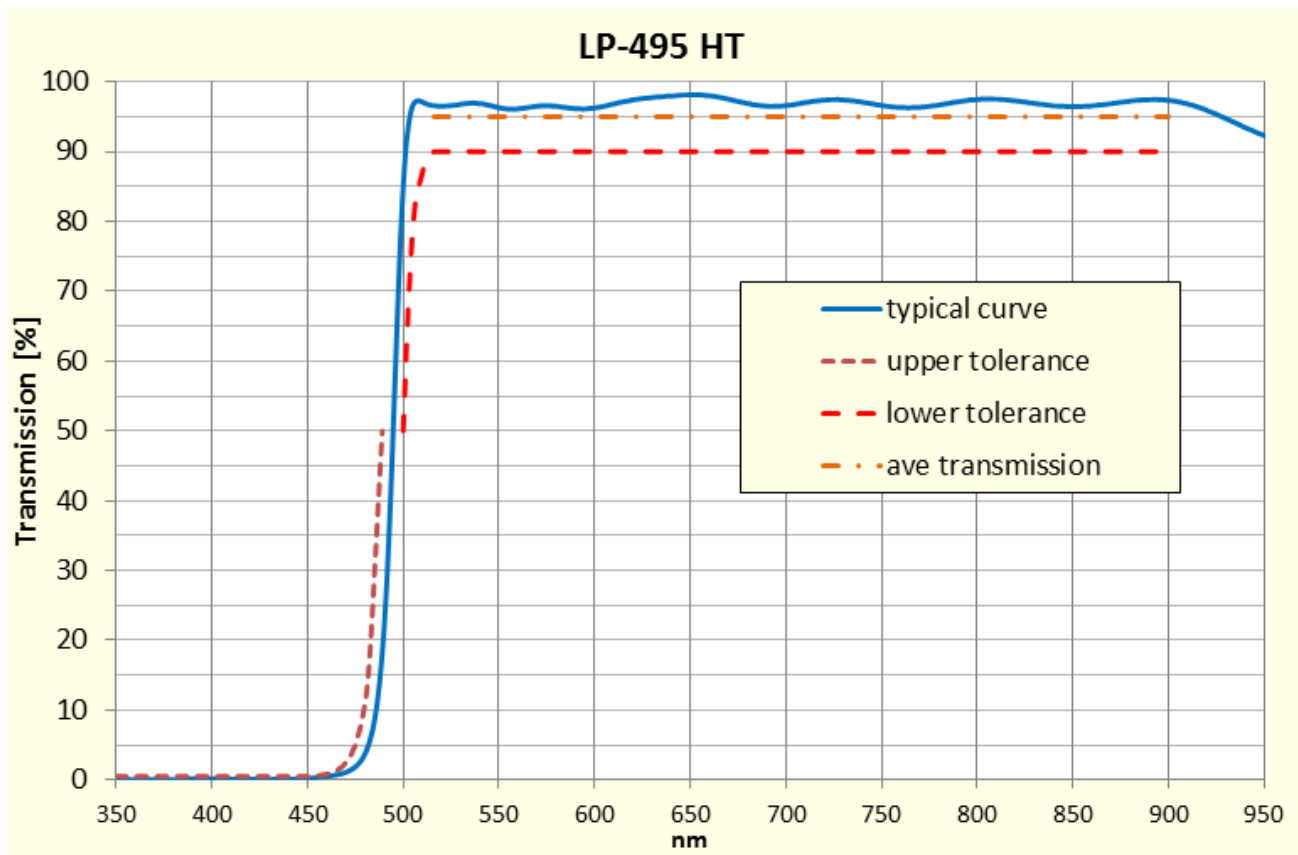

Technical specifications

according to ISO 10110

Angle of incident	0° +/- 8°
Cut-on wavelength	495 +/- 5 nm
Transmittance	515 – 900 nm: T _{ave} > 95%, T _{abs} > 90%
Blocking	UV – 450 nm: T _{abs} < 0.5%
AR coating	MCXL

unmounted	filter glass	ID	mounted	filter	ID
19 mm	IFG LP 495 HT 19,0 2-0001	1082462	CMT	IF LP 495 HT CMT	
27 mm	IFG LP 495 HT 27,0 2-0001	1082463	SH 25.5	IF LP 495 HT SH 25.5	1085388
34 mm	IFG LP 495 HT 34,0 2-0001	1082464	SH 27.0	IF LP 495 HT SH 27.0	1088074
43 mm	IFG LP 495 HT 43,0 2-0001	1082465	SN1 30.5	IF LP 495 HT SN1 30.5	
55 mm	IFG LP 495 HT 55,0 2-0001	1082466	SH 35.5	IF LP 495 HT SH 35.5	
64 mm	IFG LP 495 HT 64,0 2-0001	1082467	SH 37.0	IF LP 495 HT SH 37.0	1088125
			SH 39.0	IF LP 495 HT SH 39.0	
			SH 40.5	IF LP 495 HT SH 40.5	1085825
			SH 43.0	IF LP 495 HT SH 43.0	
			SH 46.0	IF LP 495 HT SH 46.0	
			SH 49.0	IF LP 495 HT SH 49.0	
			SH 52.0	IF LP 495 HT SH 52.0	
			SH 55.0	IF LP 495 HT SH 55.0	1085666
			SH 58.0	IF LP 495 HT SH 58.0	
			SH 62.0	IF LP 495 HT SH 62.0	
			SH 67.0	IF LP 495 HT SH 67.0	

Longpass Filter LP 515 HT

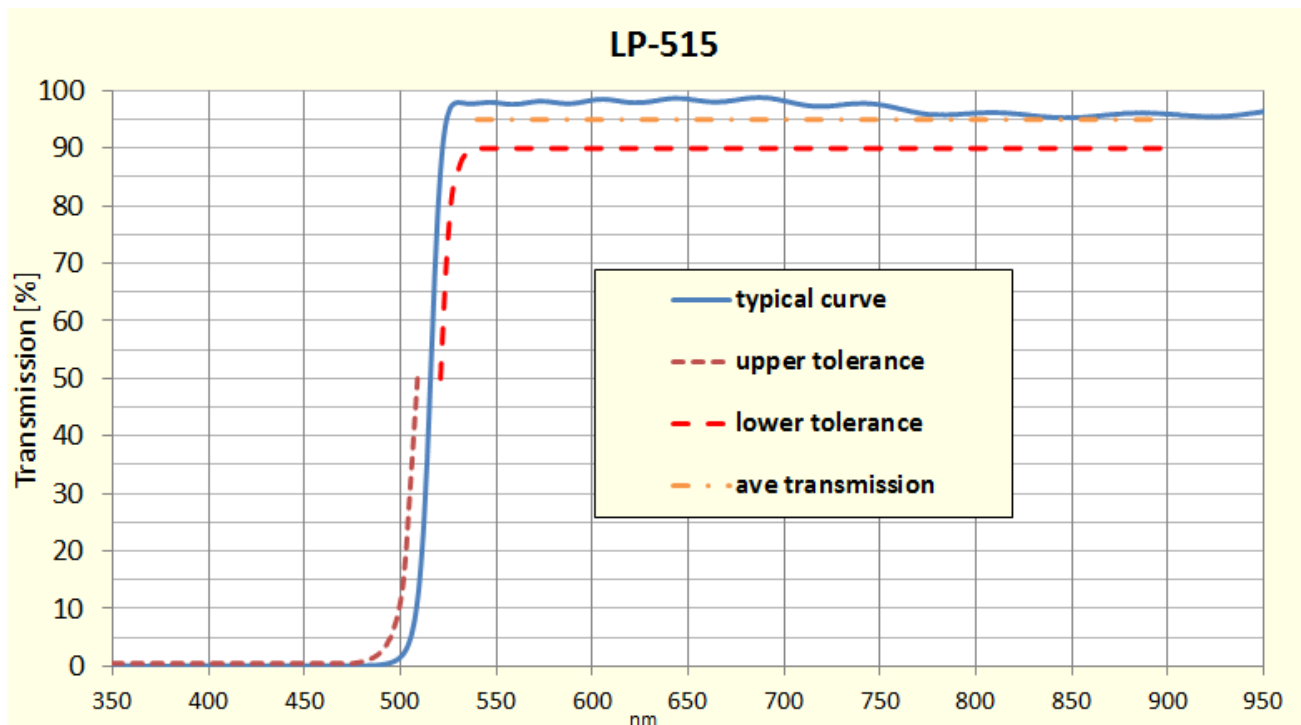

Technical specifications

according to ISO 10110

Angle of incident	0° +/- 8°
Cut-on wavelength	515 +/- 5 nm
Transmittance	540 – 900 nm: T _{ave} > 95%, T _{abs} > 90%
Blocking	UV – 475 nm: T _{abs} < 0.5%
AR coating	MCXL

unmounted	filter glass	ID	mounted	filter	ID
19 mm	IFG LP 515 HT 19,0 2-0001	1087212	CMT	IF LP 515 HT CMT	
27 mm	IFG LP 515 HT 27,0 2-0001	1087213	SH 25.5	IF LP 515 HT SH 25.5	
34 mm	IFG LP 515 HT 34,0 2-0001	1087214	SH 27.0	IF LP 515 HT SH 27.0	1088075
43 mm	IFG LP 515 HT 43,0 2-0001	1087215	SN1 30.5	IF LP 515 HT SN1 30.5	
55 mm	IFG LP 515 HT 55,0 2-0001	1087216	SH 35.5	IF LP 515 HT SH 35.5	
64 mm	IFG LP 515 HT 64,0 2-0001	1087217	SH 37.0	IF LP 515 HT SH 37.0	
			SH 39.0	IF LP 515 HT SH 39.0	
			SH 40.5	IF LP 515 HT SH 40.5	
			SH 43.0	IF LP 515 HT SH 43.0	
			SH 46.0	IF LP 515 HT SH 46.0	
			SH 49.0	IF LP 515 HT SH 49.0	
			SH 52.0	IF LP 515 HT SH 52.0	
			SH 55.0	IF LP 515 HT SH 55.0	
			SH 58.0	IF LP 515 HT SH 58.0	
			SH 62.0	IF LP 515 HT SH 62.0	
			SH 67.0	IF LP 515 HT SH 67.0	

Longpass Filter LP 530 HT

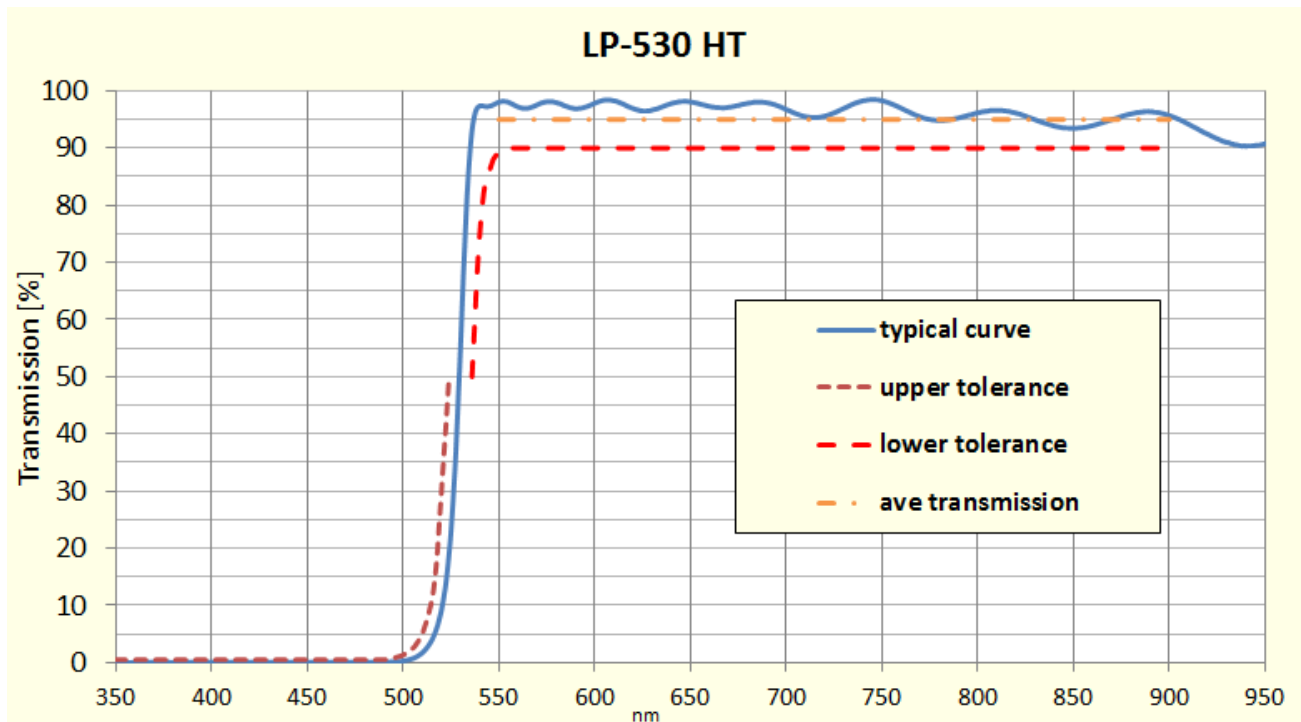

Technical specifications

according to ISO 10110

Angle of incident	0° +/- 8°
Cut-on wavelength	530 +/- 6 nm
Transmittance	550 - 900 nm: T _{ave} > 95%, T _{abs} > 90%
Blocking	UV - 490 nm: T _{abs} < 0.5%
AR coating	MCXL

unmounted	filter glass	ID	mounted	filter	ID
19 mm	IFG LP 530 HT 19,0 2-0001	1086382	CMT	IF LP 530 HT CMT	1086464
27 mm	IFG LP 530 HT 27,0 2-0001	1086383	SH 25.5	IF LP 530 HT SH 25.5	1087868
34 mm	IFG LP 530 HT 34,0 2-0001	1086384	SH 27.0	IF LP 530 HT SH 27.0	
43 mm	IFG LP 530 HT 43,0 2-0001	1086385	SN1 30.5	IF LP 530 HT SN1 30.5	
55 mm	IFG LP 530 HT 55,0 2-0001	1086386	SH 35.5	IF LP 530 HT SH 35.5	
64 mm	IFG LP 530 HT 64,0 2-0001	1086387	SH 37.0	IF LP 530 HT SH 37.0	
			SH 39.0	IF LP 530 HT SH 39.0	
			SH 40.5	IF LP 530 HT SH 40.5	
			SH 43.0	IF LP 530 HT SH 43.0	
			SH 46.0	IF LP 530 HT SH 46.0	
			SH 49.0	IF LP 530 HT SH 49.0	
			SH 52.0	IF LP 530 HT SH 52.0	
			SH 55.0	IF LP 530 HT SH 55.0	
			SH 58.0	IF LP 530 HT SH 58.0	
			SH 62.0	IF LP 530 HT SH 62.0	
			SH 67.0	IF LP 530 HT SH 67.0	

Longpass Filter LP 565 HT

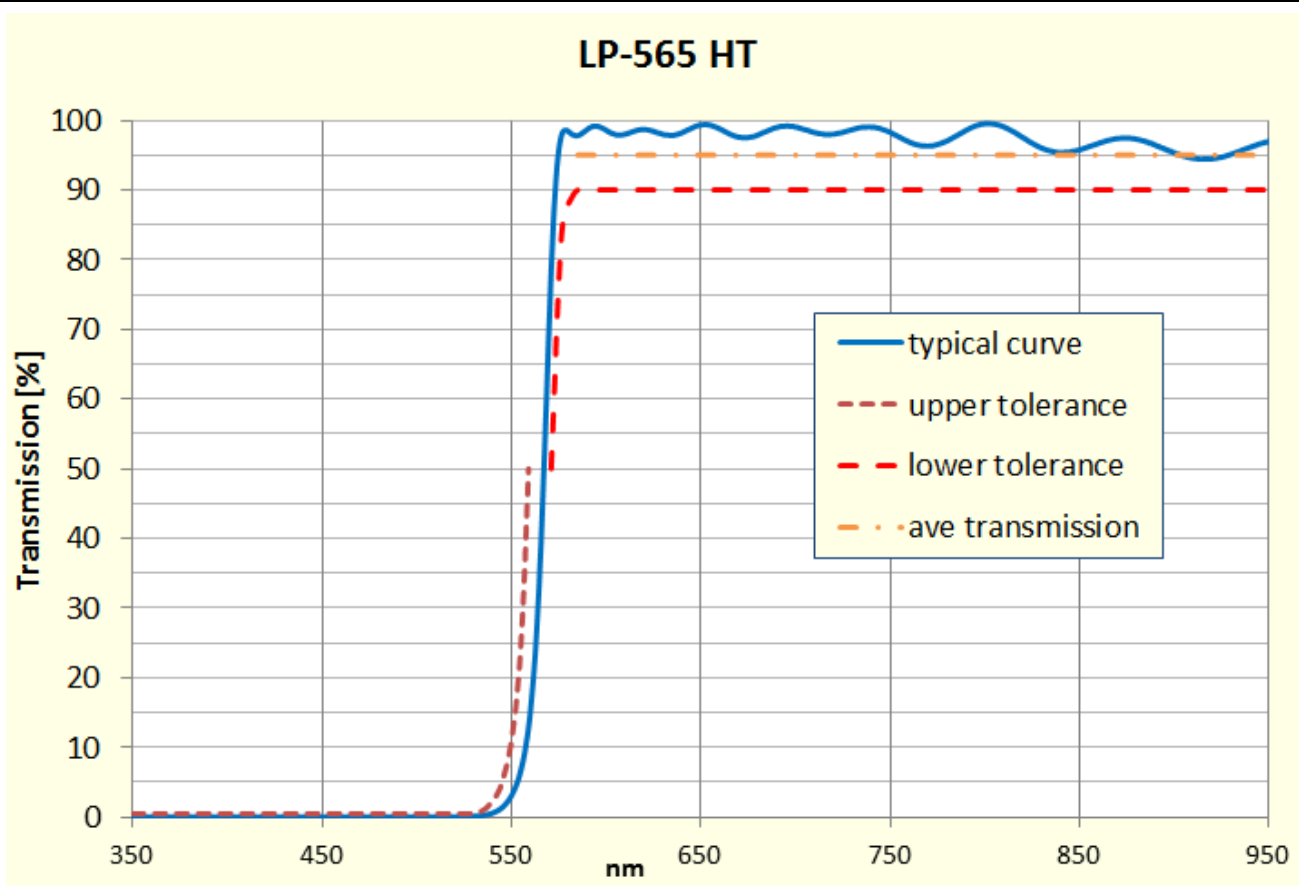

Technical specifications

according to ISO 10110

Angle of incident	0° +/- 8°
Cut-on wavelength	565 +/- 6 nm
Transmittance	585 - 950 nm: T _{ave} > 95%, T _{abs} > 90%
Blocking	UV - 530 nm: T _{abs} < 0.5%
AR coating	ULR-IR

unmounted	filter glass	ID	mounted	filter	ID
19 mm	IFG LP 565 HT 19,0 2-0001	1082493	CMT	IF LP 565 HT CMT	1086465
27 mm	IFG LP 565 HT 27,0 2-0001	1082494	SH 25.5	IF LP 565 HT SH 25.5	
34 mm	IFG LP 565 HT 34,0 2-0001	1082495	SH 27.0	IF LP 565 HT SH 27.0	
43 mm	IFG LP 565 HT 43,0 2-0001	1082496	SN1 30.5	IF LP 565 HT SN1 30.5	
55 mm	IFG LP 565 HT 55,0 2-0001	1082497	SH 35.5	IF LP 565 HT SH 35.5	1086293
64 mm	IFG LP 565 HT 64,0 2-0001	1082498	SH 37.0	IF LP 565 HT SH 37.0	
			SH 39.0	IF LP 565 HT SH 39.0	
			SH 40.5	IF LP 565 HT SH 40.5	
			SH 43.0	IF LP 565 HT SH 43.0	
			SH 46.0	IF LP 565 HT SH 46.0	
			SH 49.0	IF LP 565 HT SH 49.0	1091565
			SH 52.0	IF LP 565 HT SH 52.0	
			SH 55.0	IF LP 565 HT SH 55.0	
			SH 58.0	IF LP 565 HT SH 58.0	
			SH 62.0	IF LP 565 HT SH 62.0	
			SH 67.0	IF LP 565 HT SH 67.0	

Longpass Filter LP 590 HT

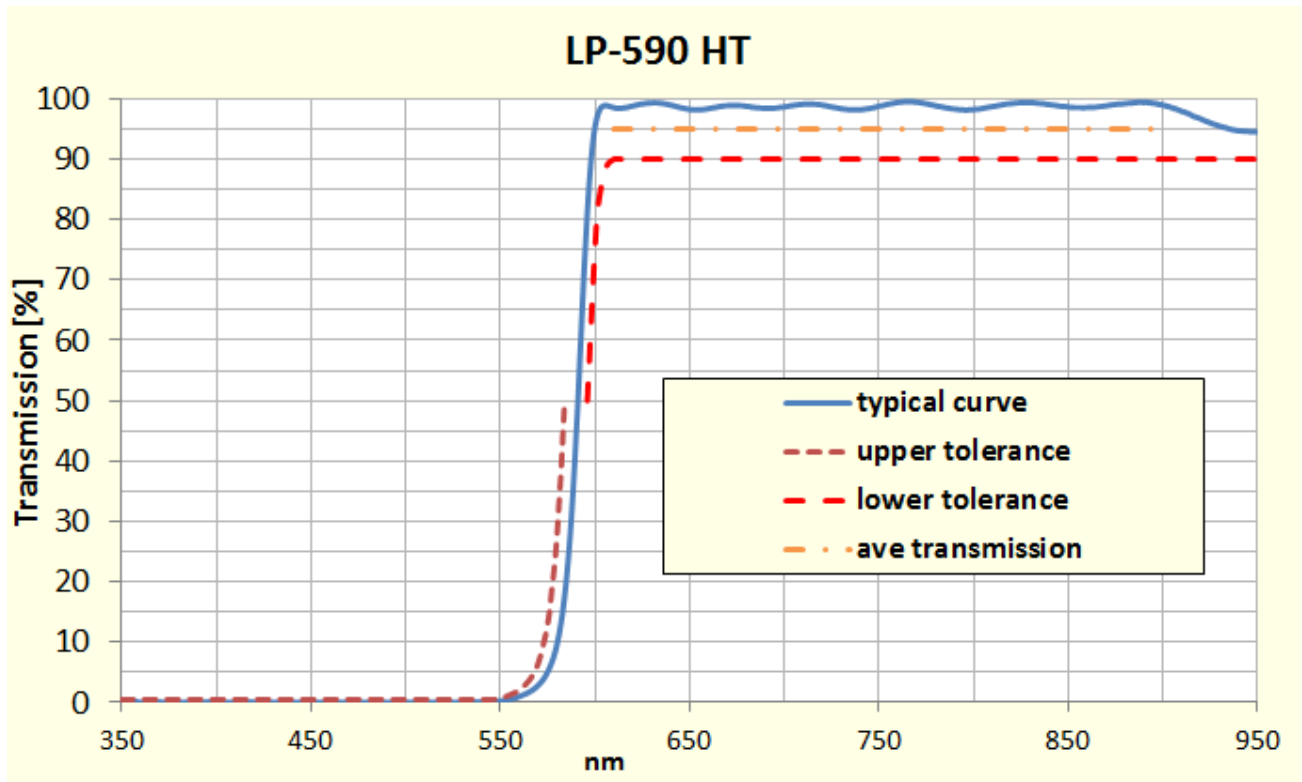

Technical specifications

according to ISO 10110

Angle of incident	0° +/- 8°
Cut-on wavelength	590 +/- 6 nm
Transmittance	610 – 900 nm: T _{ave} > 95%, T _{abs} > 90%
Blocking	UV – 545 nm: T _{abs} < 0.5%
AR coating	ULR-IR

unmounted	filter glass	ID	mounted	filter	ID
19 mm	IFG LP 590 HT 19,0 2-0001	1082505	CMT	IF LP 590 HT CMT	
27 mm	IFG LP 590 HT 27,0 2-0001	1082506	SH 25.5	IF LP 590 HT SH 25.5	
34 mm	IFG LP 590 HT 34,0 2-0001	1082507	SH 27.0	IF LP 590 HT SH 27.0	1091767
43 mm	IFG LP 590 HT 43,0 2-0001	1082508	SN1 30.5	IF LP 590 HT SN1 30.5	
55 mm	IFG LP 590 HT 55,0 2-0001	1082509	SH 35.5	IF LP 590 HT SH 35.5	
64 mm	IFG LP 590 HT 64,0 2-0001	1082510	SH 37.0	IF LP 590 HT SH 37.0	
			SH 39.0	IF LP 590 HT SH 39.0	
			SH 40.5	IF LP 590 HT SH 40.5	
			SH 43.0	IF LP 590 HT SH 43.0	
			SH 46.0	IF LP 590 HT SH 46.0	
			SH 49.0	IF LP 590 HT SH 49.0	
			SH 52.0	IF LP 590 HT SH 52.0	
			SH 55.0	IF LP 590 HT SH 55.0	
			SH 58.0	IF LP 590 HT SH 58.0	
			SH 62.0	IF LP 590 HT SH 62.0	
			SH 67.0	IF LP 590 HT SH 67.0	

Longpass Filter LP 610 HT

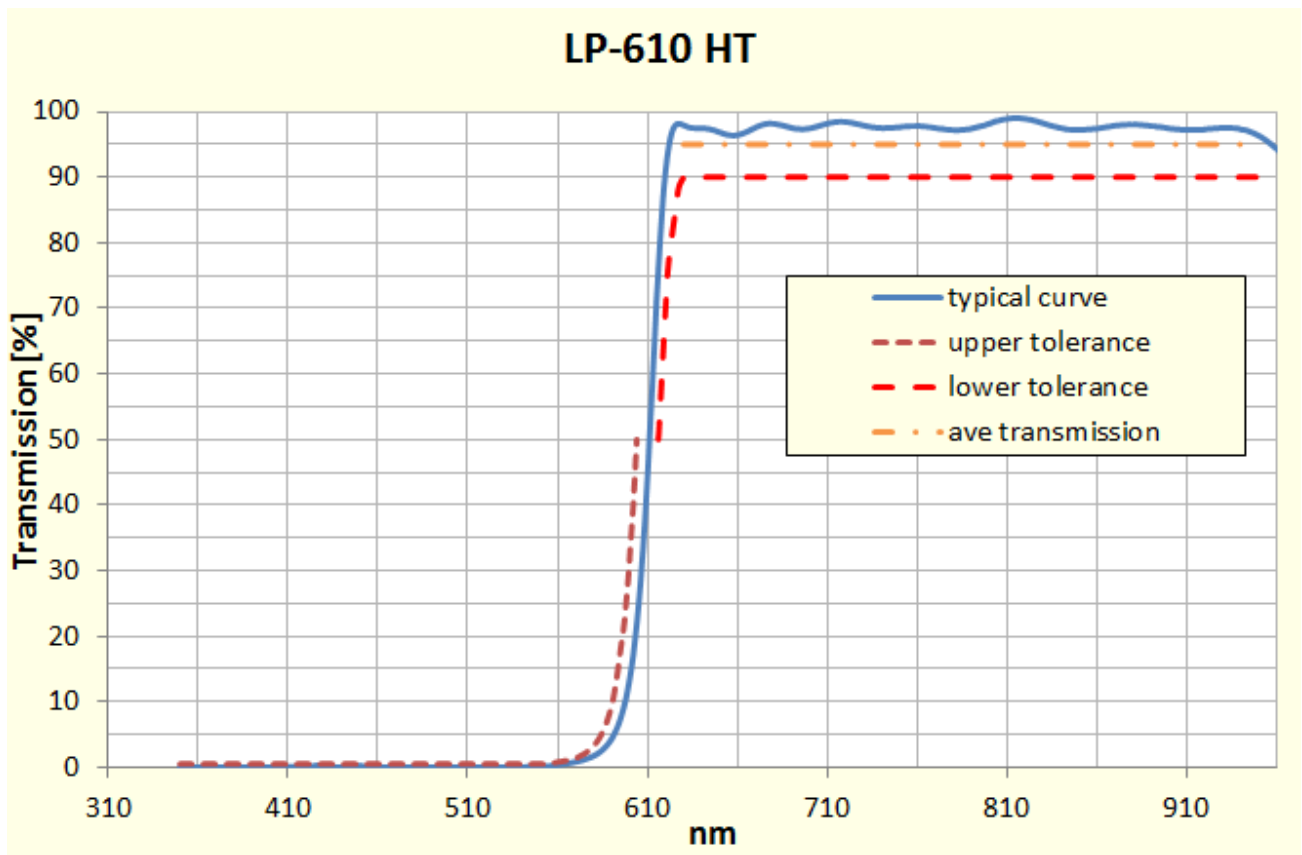

Technical specifications

according to ISO 10110

Angle of incident	0° +/- 8°
Cut-on wavelength	610 +/- 6 nm
Transmittance	630 - 950 nm: T _{ave} > 95%, T _{abs} > 90%
Blocking	UV - 550 nm: T _{abs} < 0.5%
AR coating	ULR-IR

unmounted	filter glass	ID	mounted	filter	ID
19 mm	IFG LP 610 HT 19,0 2-0001	1082511	CMT	IF LP 61 0 HT CMT	
27 mm	IFG LP 610 HT 27,0 2-0001	1082512	SH 25.5	IF LP 610 HT SH 25.5	1088045
34 mm	IFG LP 610 HT 34,0 2-0001	1082513	SH 27.0	IF LP 610 HT SH 27.0	
43 mm	IFG LP 610 HT 43,0 2-0001	1082514	SN1 30.5	IF LP 610 HT SN1 30.5	
55 mm	IFG LP 610 HT 55,0 2-0001	1082515	SH 35.5	IF LP 610 HT SH 35.5	
64 mm	IFG LP 610 HT 64,0 2-0001	1082516	SH 37.0	IF LP 610 HT SH 37.0	
			SH 39.0	IF LP 610 HT SH 39.0	
			SH 40.5	IF LP 610 HT SH 40.5	
			SH 43.0	IF LP 610 HT SH 43.0	
			SH 46.0	IF LP 610 HT SH 46.0	
			SH 49.0	IF LP 610 HT SH 49.0	
			SH 52.0	IF LP 610 HT SH 52.0	
			SH 55.0	IF LP 610 HT SH 55.0	
			SH 58.0	IF LP 610 HT SH 58.0	
			SH 62.0	IF LP 610 HT SH 62.0	
			SH 67.0	IF LP 610 HT SH 67.0	

Longpass Filter LP 630 HT

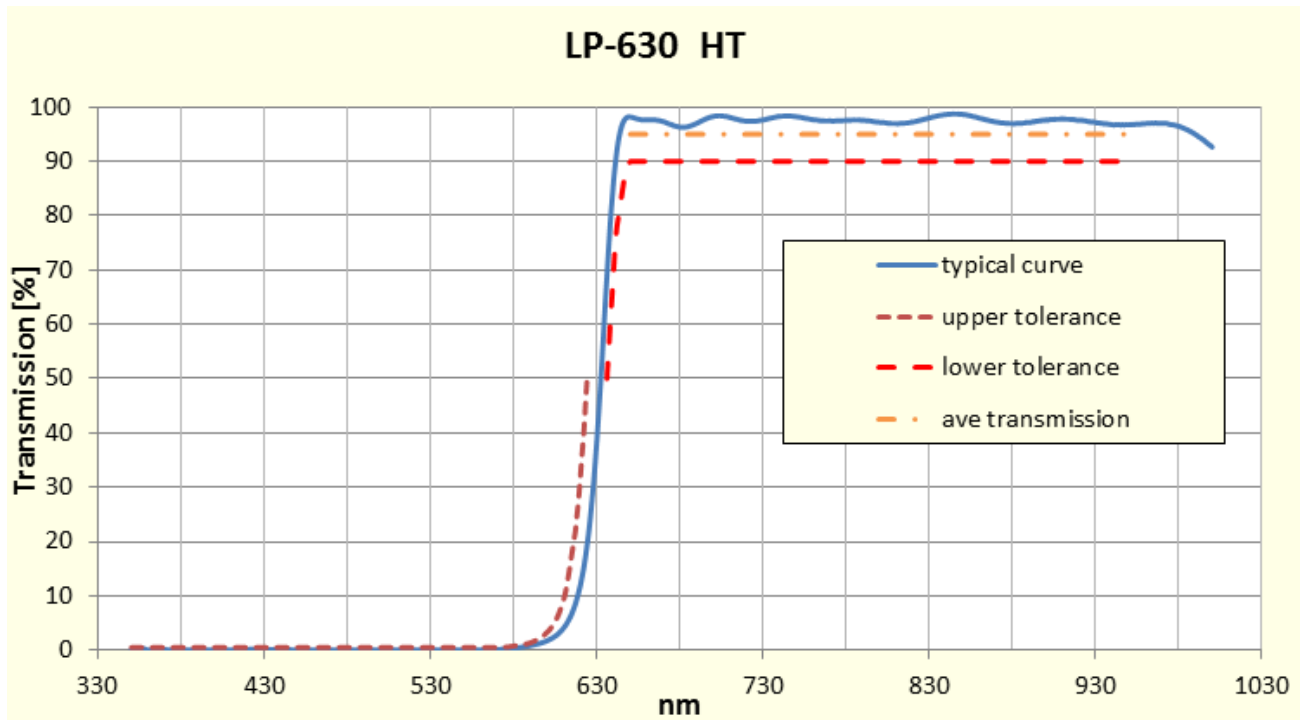

Technical specifications

according to ISO 10110

Angle of incident	0° +/- 8°
Cut-on wavelength	630 +/- 6nm
Transmittance	650 - 950 nm: T _{ave} > 95%, T _{abs} > 90%
Blocking	UV - 570 nm: T _{abs} < 0.5%
AR coating	ULR-IR

unmounted	filter glass	ID	mounted	filter	ID
19 mm	IFG LP 630 HT 19,0 2-0001	1082474	CMT	IF LP 630 HT CMT	
27 mm	IFG LP 630 HT 27,0 2-0001	1082475	SH 25.5	IF LP 630 HT SH 25.5	
34 mm	IFG LP 630 HT 34,0 2-0001	1082476	SH 27.0	IF LP 630 HT SH 27.0	
43 mm	IFG LP 630 HT 43,0 2-0001	1082477	SN1 30.5	IF LP 630 HT SN1 30.5	1088645
55 mm	IFG LP 630 HT 55,0 2-0001	1082478	SH 35.5	IF LP 630 HT SH 35.5	
64 mm	IFG LP 630 HT 64,0 2-0001	1082479	SH 37.0	IF LP 630 HT SH 37.0	
			SH 39.0	IF LP 630 HT SH 39.0	1088646
			SH 40.5	IF LP 630 HT SH 40.5	
			SH 43.0	IF LP 630 HT SH 43.0	
			SH 46.0	IF LP 630 HT SH 46.0	
			SH 49.0	IF LP 630 HT SH 49.0	
			SH 52.0	IF LP 630 HT SH 52.0	
			SH 55.0	IF LP 630 HT SH 55.0	
			SH 58.0	IF LP 630 HT SH 58.0	
			SH 62.0	IF LP 630 HT SH 62.0	
			SH 67.0	IF LP 630 HT SH 67.0	

Longpass Filter LP 695 HT

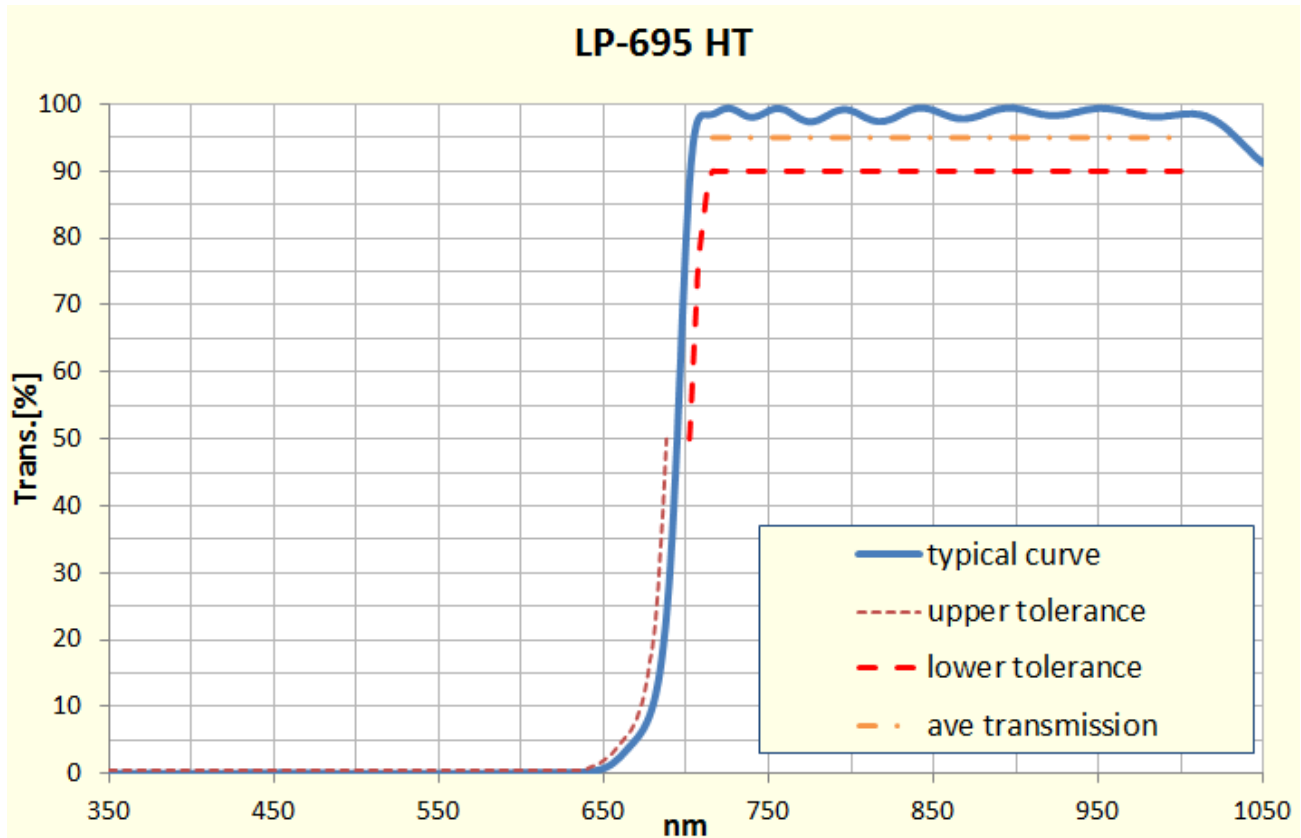

Technical specifications

according to ISO 10110

Angle of incident	0° +/-8°
Cut-on wavelength	695 +/- 7nm
Transmittance	715 - 1000 nm: T _{ave} > 95%, T _{abs} > 90%
Blocking	UV - 635 nm: T _{abs} < 0.5%
AR coating	ULR-IR

unmounted	filter glass	ID	mounted	filter	ID
19 mm	IFG LP 695 HT 19,0 2-0001	1082480	CMT	IF LP 695 HT CMT	
27 mm	IFG LP 695 HT 27,0 2-0001	1082481	SH 25.5	IF LP 695 HT SH 25.5	1085968
34 mm	IFG LP 695 HT 34,0 2-0001	1082482	SH 27.0	IF LP 695 HT SH 27.0	1087247
43 mm	IFG LP 695 HT 43,0 2-0001	1082483	SN1 30.5	IF LP 695 HT SN1 30.5	1084449
55 mm	IFG LP 695 HT 55,0 2-0001	1082484	SH 35.5	IF LP 695 HT SH 35.5	
64 mm	IFG LP 695 HT 64,0 2-0001	1082485	SH 37.0	IF LP 695 HT SH 37.0	1089814
			SH 39.0	IF LP 695 HT SH 39.0	1090588
			SH 40.5	IF LP 695 HT SH 40.5	
			SH 43.0	IF LP 695 HT SH 43.0	
			SH 46.0	IF LP 695 HT SH 46.0	
			SH 49.0	IF LP 695 HT SH 49.0	
			SH 52.0	IF LP 695 HT SH 52.0	1090083
			SH 55.0	IF LP 695 HT SH 55.0	1087746
			SH 58.0	IF LP 695 HT SH 58.0	
			SH 62.0	IF LP 695 HT SH 62.0	
			SH 67.0	IF LP 695 HT SH 67.0	

Longpass Filter LP 725 HT

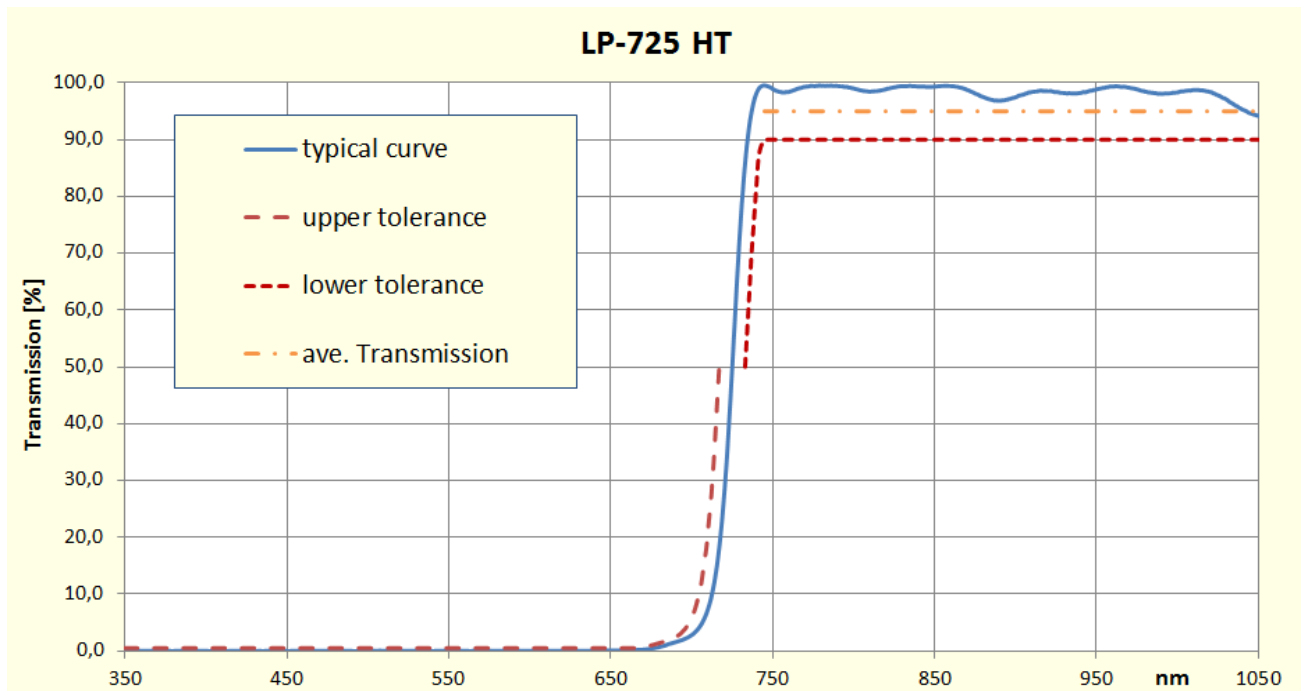

Technical specifications

according to ISO 10110

Angle of incident	0° +/- 8°
Cut-on wavelength	725 +/- 8nm
Transmittance	750 - 1050 nm: T _{ave} > 95%, T _{abs} > 90% 1050 – 1700 nm T _{ave} > 85%
Blocking	UV - 670 nm: T _{abs} < 0.5%
AR coating	ULR-IR

unmounted	filter glass	ID	mounted	filter	ID
19 mm	IFG LP 725 HT 19,0 2-0001		CMT	IF LP 725 HT CMT	
27 mm	IFG LP 725 HT 27,0 2-0001		SH 25.5	IF LP 725 HT SH 25.5	
34 mm	IFG LP 725 HT 34,0 2-0001		SH 27.0	IF LP 725 HT SH 27.0	
43 mm	IFG LP 725 HT 43,0 2-0001		SN1 30.5	IF LP 725 HT SN1 30.5	
55 mm	IFG LP 725 HT 55,0 2-0001		SH 35.5	IF LP 725 HT SH 35.5	
64 mm	IFG LP 725 HT 64,0 2-0001		SH 37.0	IF LP 725 HT SH 37.0	
			SH 39.0	IF LP 725 HT SH 39.0	
			SH 40.5	IF LP 725 HT SH 40.5	
			SH 43.0	IF LP 725 HT SH 43.0	
			SH 46.0	IF LP 725 HT SH 46.0	
			SH 49.0	IF LP 725 HT SH 49.0	
			SH 52.0	IF LP 725 HT SH 52.0	
			SH 55.0	IF LP 725 HT SH 55.0	
			SH 58.0	IF LP 725 HT SH 58.0	
			SH 62.0	IF LP 725 HT SH 62.0	
			SH 67.0	IF LP 725 HT SH 67.0	

Longpass Filter LP 765 HT

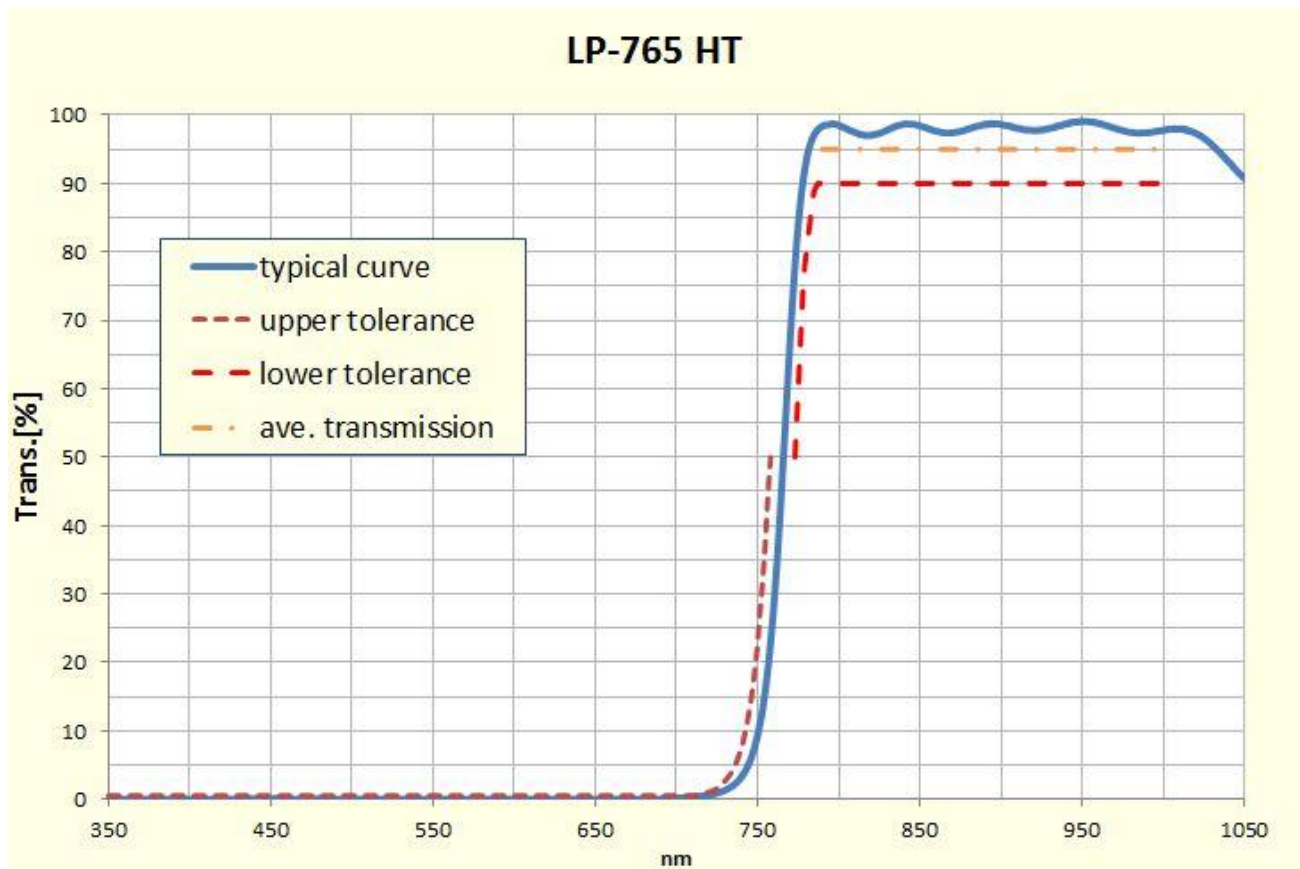

Technical specifications

according to ISO 10110

Angle of incident	0° +/-8°
Cut-on wavelength	765 +/- 8nm
Transmittance	790 - 1000 nm: T _{ave} > 95%, T _{abs} > 90%
Blocking	UV - 710 nm: T _{abs} < 0.5%
AR coating	ULR-IR

unmounted	filter glass	ID	mounted	filter	ID
19 mm	IFG LP 765 HT 19,0 2-0001	1085345	CMT	IF LP 765 HT CMT	
27 mm	IFG LP 765 HT 27,0 2-0001	1085346	SH 25.5	IF LP 765 HT SH 25.5	
34 mm	IFG LP 765 HT 34,0 2-0001	1085347	SH 27.0	IF LP 765 HT SH 27.0	
43 mm	IFG LP 765 HT 43,0 2-0001	1085348	SN1 30.5	IF LP 765 HT SN1 30.5	1085795
55 mm	IFG LP 765 HT 55,0 2-0001	1085349	SH 35.5	IF LP 765 HT SH 35.5	1086473
64 mm	IFG LP 765 HT 64,0 2-0001	1085350	SH 37.0	IF LP 765 HT SH 37.0	1085796
			SH 39.0	IF LP 765 HT SH 39.0	1090588
			SH 40.5	IF LP 765 HT SH 40.5	1087682
			SH 43.0	IF LP 765 HT SH 43.0	
			SH 46.0	IF LP 765 HT SH 46.0	1086640
			SH 49.0	IF LP 765 HT SH 49.0	
			SH 52.0	IF LP 765 HT SH 52.0	
			SH 55.0	IF LP 765 HT SH 55.0	
			SH 58.0	IF LP 765 HT SH 58.0	1085528
			SH 62.0	IF LP 765 HT SH 62.0	
			SH 67.0	IF LP 765 HT SH 67.0	

Longpass Filter LP 780 HT

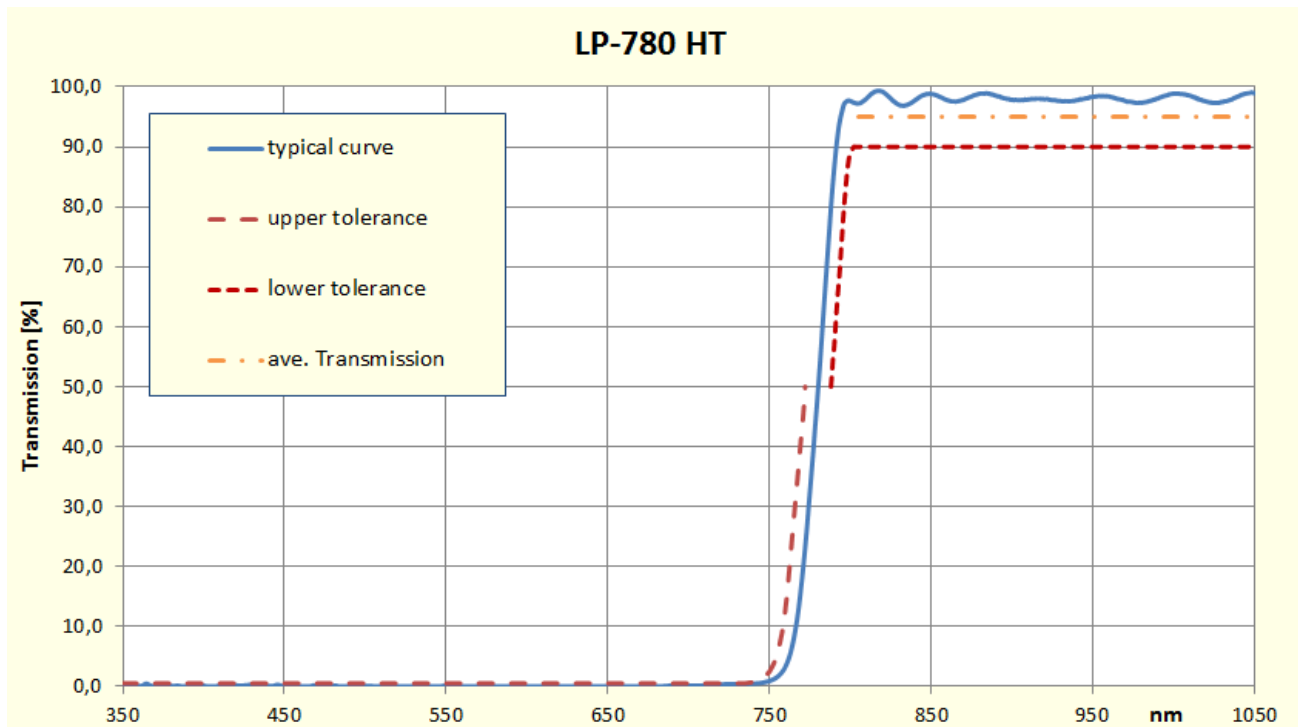

Technical specifications

according to ISO 10110

Angle of incident	0° +/- 8°
Cut-on wavelength	780 +/- 8nm
Transmittance	805 - 1050 nm: T _{ave} > 85%, T _{abs} > 90% 1050 – 1700 nm T _{ave} > 80%
Blocking	UV - 735 nm: T _{abs} < 0.5%
AR coating	ULR-IR

unmounted	filter glass	ID	mounted	filter	ID
19 mm	IFG LP 780 HT 19,0 2-0001		CMT	IF LP 780 HT CMT	
27 mm	IFG LP 780 HT 27,0 2-0001		SH 25.5	IF LP 780 HT SH 25.5	
34 mm	IFG LP 780 HT 34,0 2-0001		SH 27.0	IF LP 780 HT SH 27.0	
43 mm	IFG LP 780 HT 43,0 2-0001		SN1 30.5	IF LP 780 HT SN1 30.5	
55 mm	IFG LP 780 HT 55,0 2-0001		SH 35.5	IF LP 780 HT SH 35.5	
64 mm	IFG LP 780 HT 64,0 2-0001		SH 37.0	IF LP 780 HT SH 37.0	
			SH 39.0	IF LP 780 HT SH 39.0	
			SH 40.5	IF LP 780 HT SH 40.5	
			SH 43.0	IF LP 780 HT SH 43.0	
			SH 46.0	IF LP 780 HT SH 46.0	
			SH 49.0	IF LP 780 HT SH 49.0	
			SH 52.0	IF LP 780 HT SH 52.0	
			SH 55.0	IF LP 780 HT SH 55.0	
			SH 58.0	IF LP 780 HT SH 58.0	
			SH 62.0	IF LP 780 HT SH 62.0	
			SH 67.0	IF LP 780 HT SH 67.0	

Longpass Filter LP 820 HT

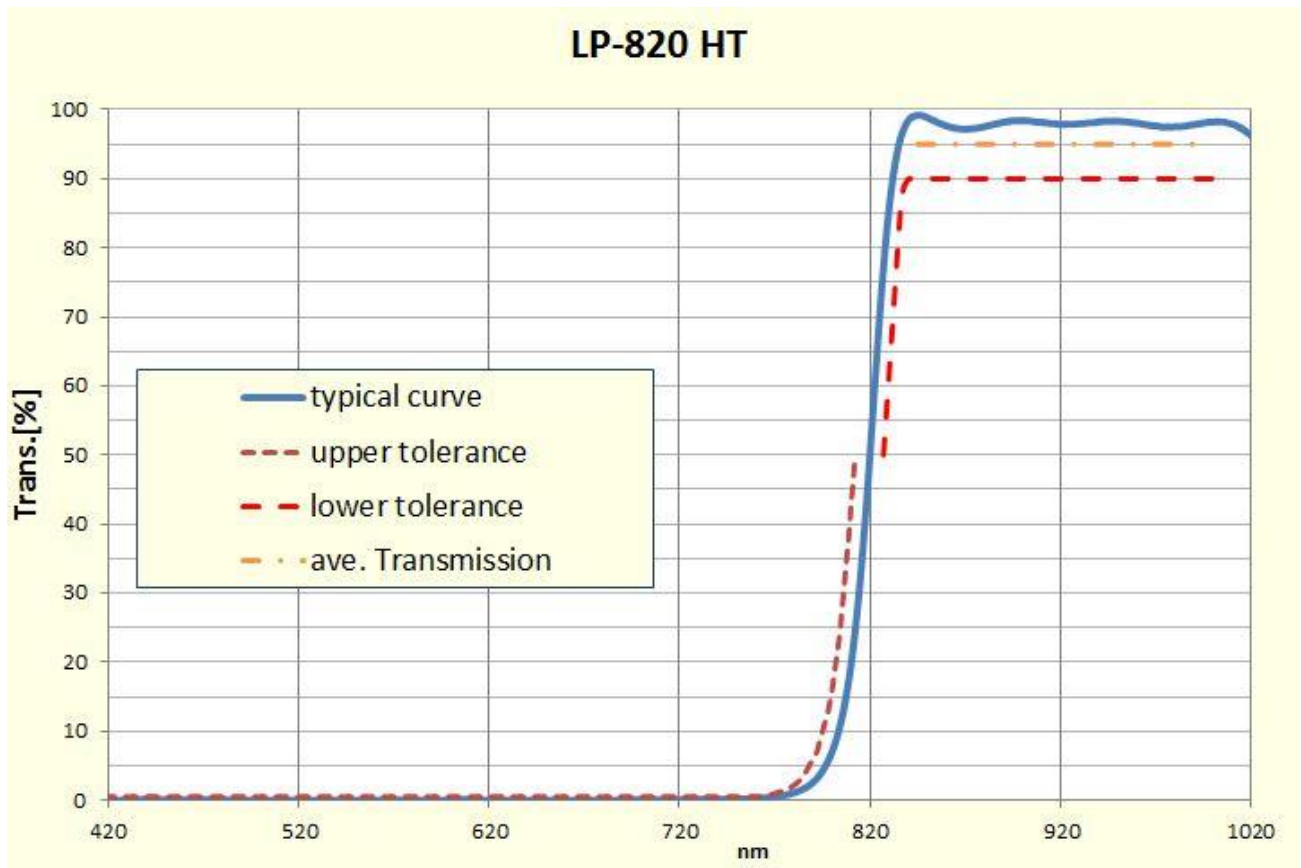

Technical specifications

according to ISO 10110

Angle of incident	0° +/-8°
Cut-on wavelength	820 +/- 8nm
Transmittance	850 - 1000 nm: T _{ave} > 95%, 840 -1010: T _{abs} > 90%
Blocking	UV - 760 nm: T _{abs} < 0.5%
AR coating	ULR-IR

unmounted	filter glass	ID	mounted	filter	ID
19 mm	IFG LP 820 HT 19,0 2-0001	1082481	CMT	IF LP 820 HT CMT	
27 mm	IFG LP 820 HT 27,0 2-0001	1082482	SH 25.5	IF LP 820 HT SH 25.5	1087228
34 mm	IFG LP 820 HT 34,0 2-0001	1082483	SH 27.0	IF LP 820 HT SH 27.0	1086965
43 mm	IFG LP 820 HT 43,0 2-0001	1082484	SN1 30.5	IF LP 820 HT SN1 30.5	1088115
55 mm	IFG LP 820 HT 55,0 2-0001	1082486	SH 35.5	IF LP 820 HT SH 35.5	
64 mm	IFG LP 820 HT 64,0 2-0001	1082487	SH 37.0	IF LP 820 HT SH 37.0	1085793
			SH 39.0	IF LP 820 HT SH 39.0	
			SH 40.5	IF LP 820 HT SH 40.5	1090151
			SH 43.0	IF LP 820 HT SH 43.0	
			SH 46.0	IF LP 820 HT SH 46.0	1086642
			SH 49.0	IF LP 820 HT SH 49.0	
			SH 52.0	IF LP 820 HT SH 52.0	
			SH 55.0	IF LP 820 HT SH 55.0	
			SH 58.0	IF LP 820 HT SH 58.0	1088359
			SH 62.0	IF LP 820 HT SH 62.0	
			SH 67.0	IF LP 820 HT SH 67.0	

Longpass Filter LP 850 HT

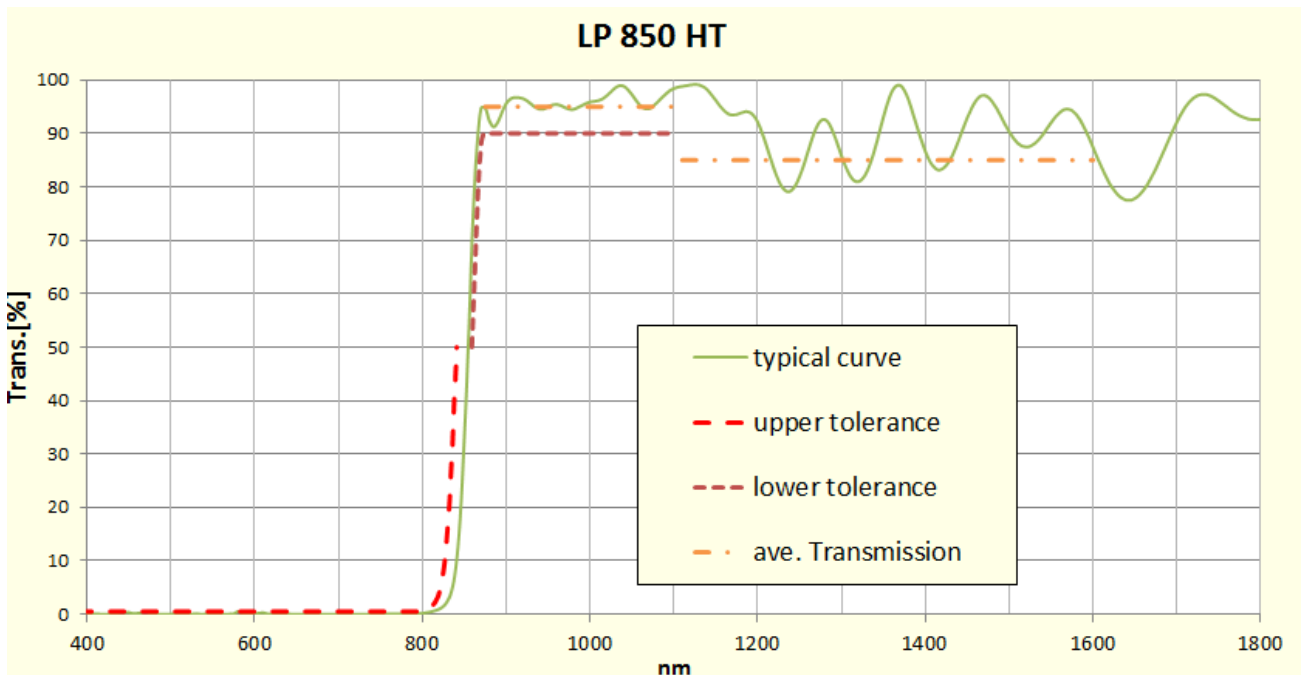

Technical specifications

according to ISO 10110

Angle of incident	0° +/- 8°
Cut-on wavelength	850 +/- 9nm
Transmittance	875 - 1050 nm: T _{ave} > 95%, T _{abs} > 90% 1050 – 1700 nm T _{ave} > 85%
Blocking	UV - 800 nm: T _{abs} < 0.5%
AR coating	ULR-IR/Typ2

unmounted	filter glass	ID	mounted	filter	ID
19 mm	IFG LP 850 HT 19,0 2-0001		CMT	IF LP 850 HT CMT	
27 mm	IFG LP 850 HT 27,0 2-0001		SH 25.5	IF LP 850 HT SH 25.5	
34 mm	IFG LP 850 HT 34,0 2-0001		SH 27.0	IF LP 850 HT SH 27.0	
43 mm	IFG LP 850 HT 43,0 2-0001		SN1 30.5	IF LP 850 HT SN1 30.5	
55 mm	IFG LP 850 HT 55,0 2-0001		SH 35.5	IF LP 850 HT SH 35.5	
64 mm	IFG LP 850 HT 64,0 2-0001		SH 37.0	IF LP 850 HT SH 37.0	
			SH 39.0	IF LP 850 HT SH 39.0	
			SH 40.5	IF LP 850 HT SH 40.5	
			SH 43.0	IF LP 850 HT SH 43.0	
			SH 46.0	IF LP 850 HT SH 46.0	
			SH 49.0	IF LP 850 HT SH 49.0	
			SH 52.0	IF LP 850 HT SH 52.0	
			SH 55.0	IF LP 850 HT SH 55.0	
			SH 58.0	IF LP 850 HT SH 58.0	
			SH 62.0	IF LP 850 HT SH 62.0	
			SH 67.0	IF LP 850 HT SH 67.0	

Longpass Filter LP 900 HT

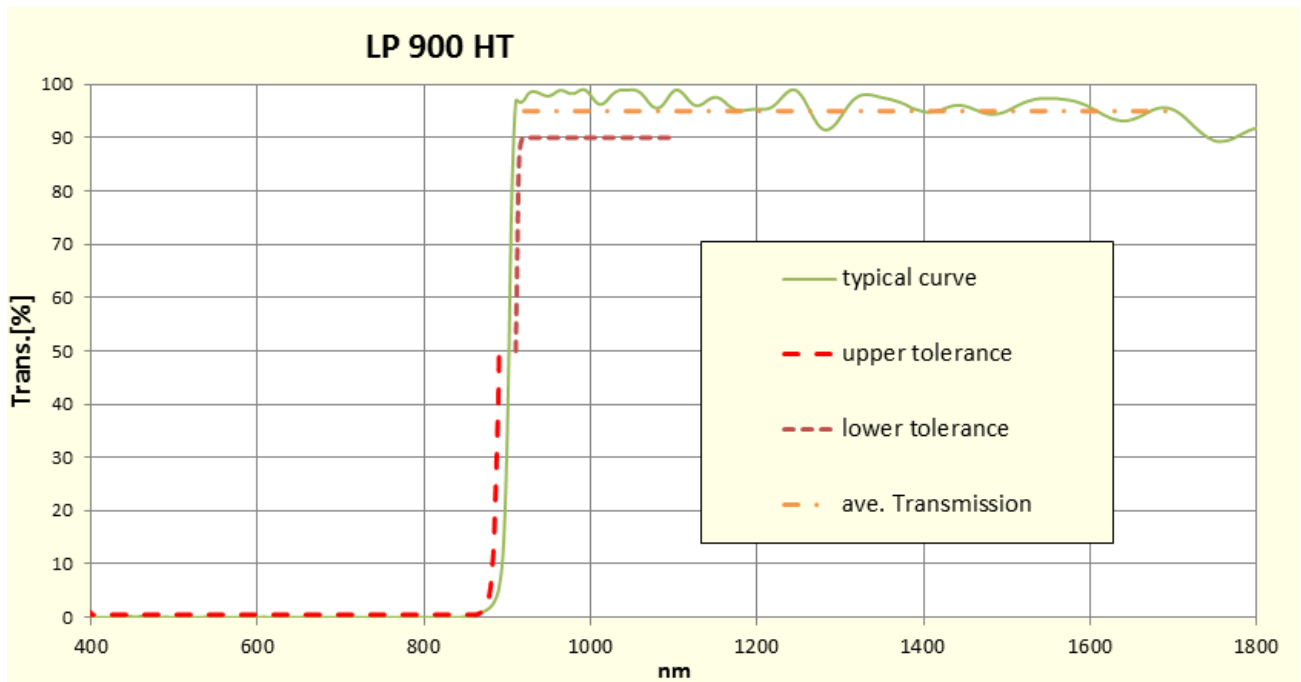

Technical specifications

according to ISO 10110

Angle of incident	0° +/-8°
Cut-on wavelength	900 +/- 10nm
Transmittance	920 - 1100 nm: T _{abs} > 90% 920 – 1700 nm: T _{ave} > 95%
Blocking	UV - 400 nm: T _{abs} < 1.0% 400 - 860 nm: T _{abs} < 0.5%
AR coating	ULR-IR/Typ2

unmounted	filter glass	ID	mounted	filter	ID
19 mm	IFG LP 900 HT 19,0 2-0001		CMT	IF LP 900 HT CMT	
27 mm	IFG LP 900 HT 27,0 2-0001		SH 25.5	IF LP 900 HT SH 25.5	
34 mm	IFG LP 900 HT 34,0 2-0001		SH 27.0	IF LP 900 HT SH 27.0	
43 mm	IFG LP 900 HT 43,0 2-0001		SN1 30.5	IF LP 900 HT SN1 30.5	
55 mm	IFG LP 900 HT 55,0 2-0001		SH 35.5	IF LP 900 HT SH 35.5	
64 mm	IFG LP 900 HT 64,0 2-0001		SH 37.0	IF LP 900 HT SH 37.0	
			SH 39.0	IF LP 900 HT SH 39.0	
			SH 40.5	IF LP 900 HT SH 40.5	
			SH 43.0	IF LP 900 HT SH 43.0	
			SH 46.0	IF LP 900 HT SH 46.0	
			SH 49.0	IF LP 900 HT SH 49.0	
			SH 52.0	IF LP 900 HT SH 52.0	1091701
			SH 55.0	IF LP 900 HT SH 55.0	
			SH 58.0	IF LP 900 HT SH 58.0	
			SH 62.0	IF LP 900 HT SH 62.0	
			SH 67.0	IF LP 900 HT SH 67.0	

Longpass Filter

Next to the standard sizes we offer more on request. Schneider-Kreuznach provides professional highly accurate μ water jet cutting capability. This technology allows cutting almost any needed shape. More mounted diameters are available for high volume on request.

An easy method to create a customized band pass is to combine a longpass filter with a shortpass filter. This is an effective way when the standard range of bandpass filters does not fit the application. Schneider-Kreuznach offers a series of longpass filters and of shortpass filters.

See also Schneider-Kreuznach bandpass filters as alternative.

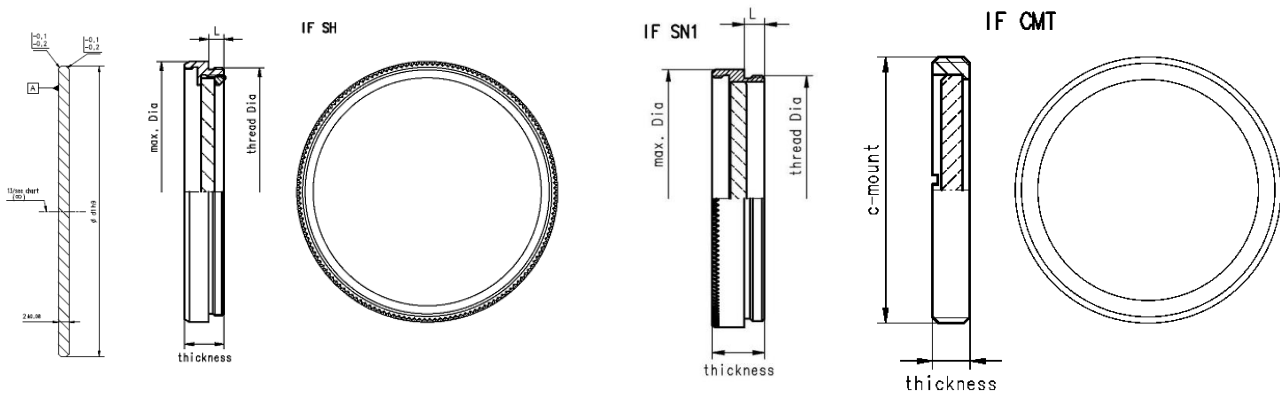

Contact

Jos. Schneider Optische Werke GmbH
 Ringstraße 132
 55543 Bad Kreuznach
 Germany
 Phone +49 671 601-205
 Fax +49 671 601-81-205
www.schneiderkreuznach.com
industrie@schneiderkreuznach.com

Schneider Optical Technologies Co., Ltd.
 Rm. A505 Yingdali Science Park, Hongmian Rd.,
 Futian Free Trade Zone, Shenzhen 518038,
 P.R. China
 Phone: +86 755 88 32 11 70
 Fax: +86 755 88 32 11 75
www.schneiderkreuznach.com
info@schneider-asiapacific.com

Schneider Optics Inc.
 285 Oser Ave.
 Hauppauge, NY 11788
 USA
 Phone +1 631 761-5000
 Fax +1 631 761-5090
www.schneideroptics.com
oem@schneideroptics.com